

凌科自动化



**SRX**





---









2010 E2

2010 E2

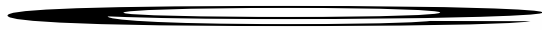

0

1

---









-----











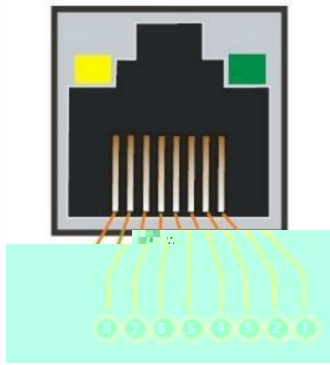









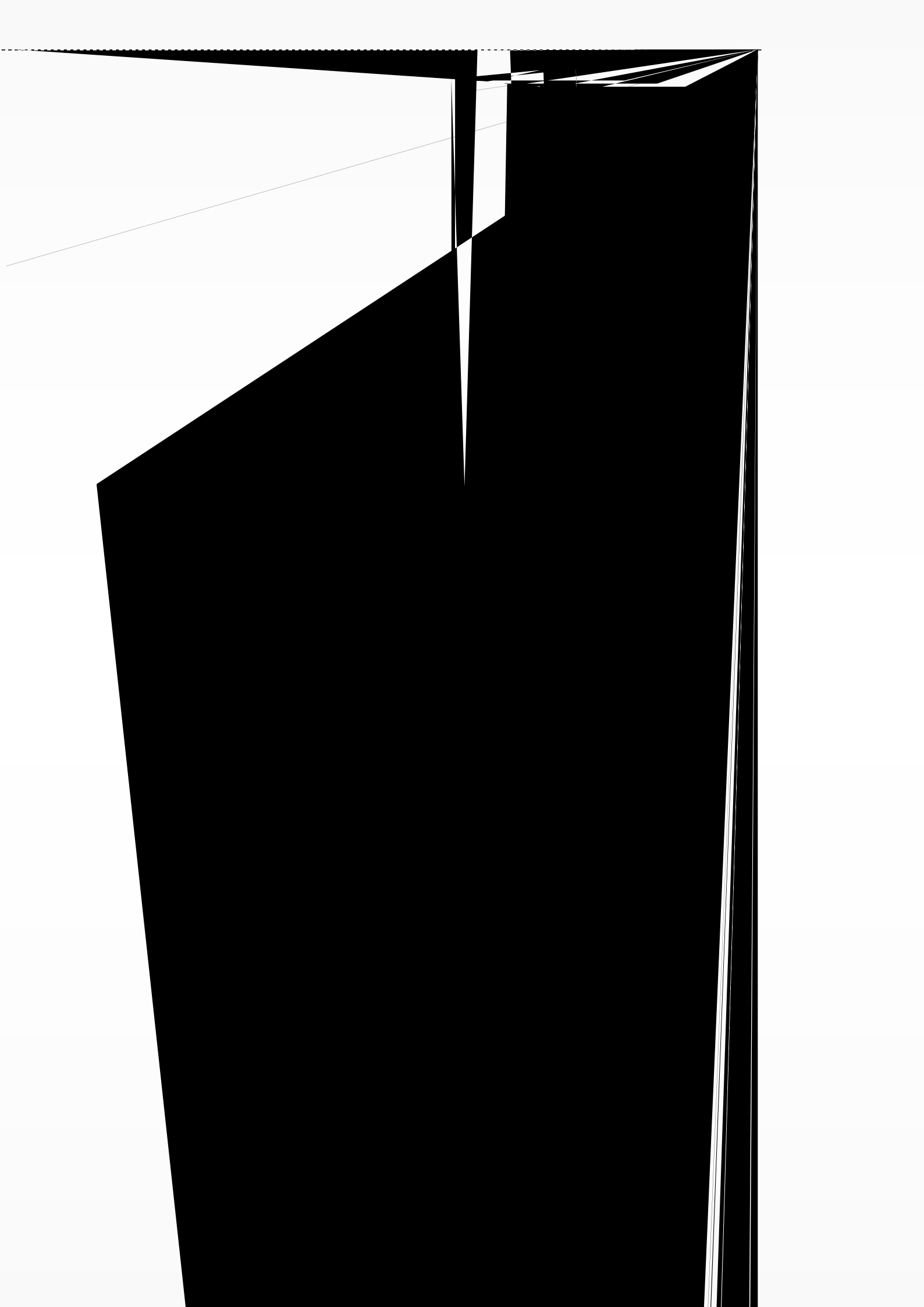

# SRX-DO808N-EA

DI

X4

DO

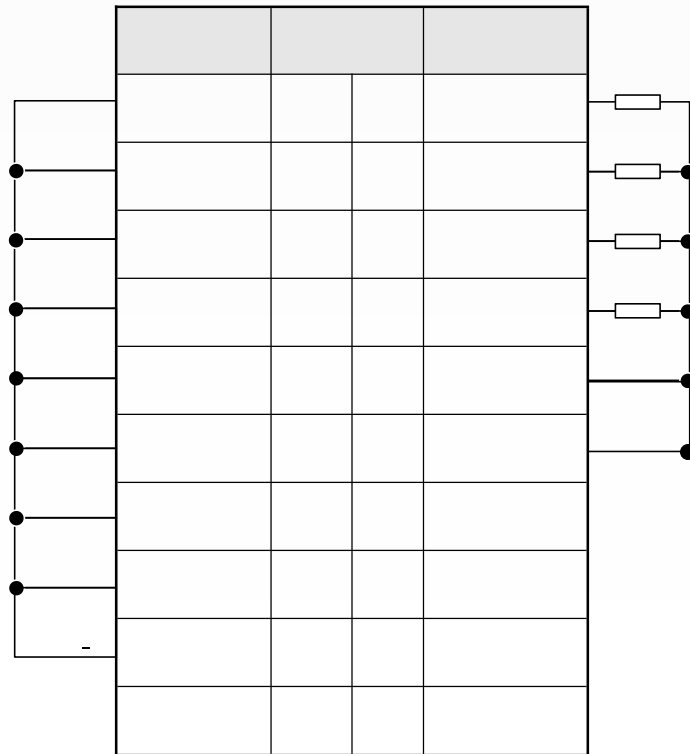



# SRX-DO016P-EA

DO

X4

DO

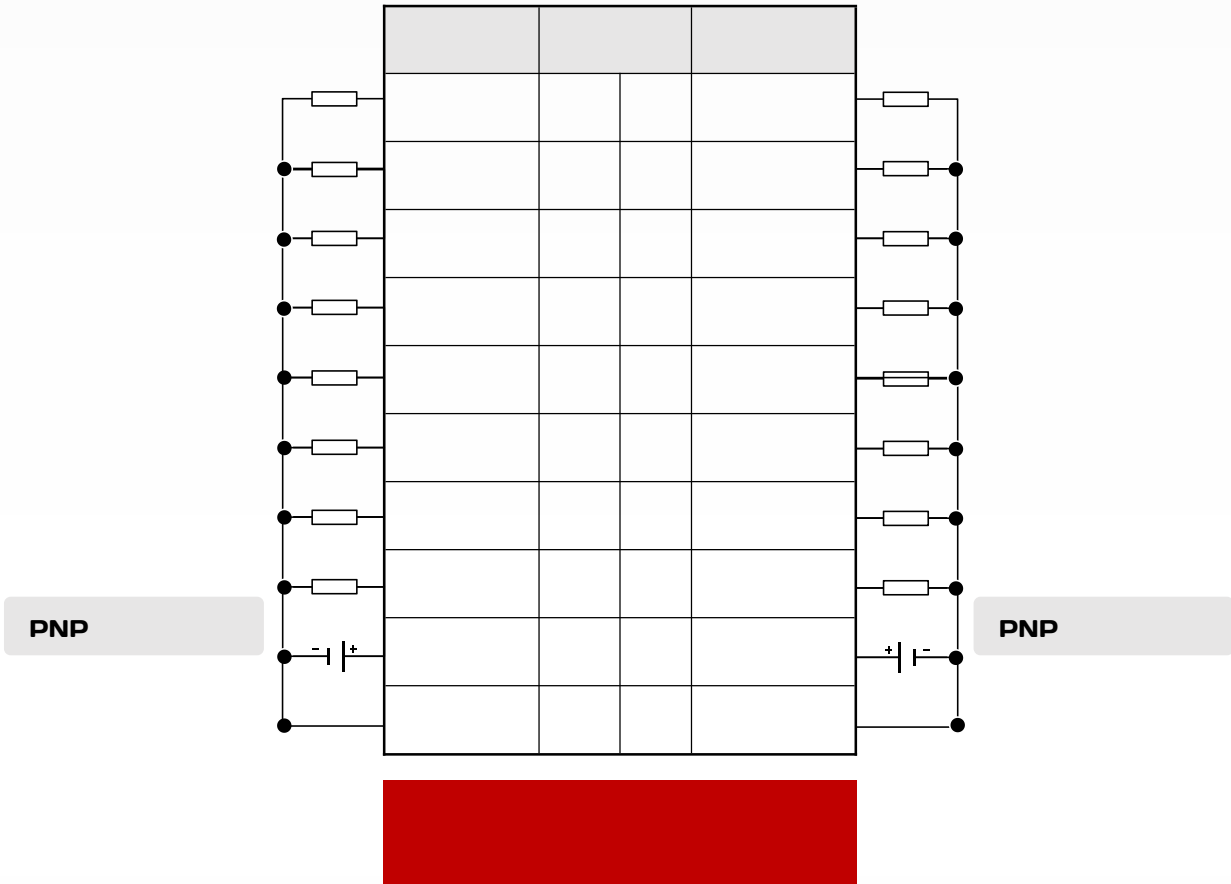

PNP

PNP

**SRX-D0016N-EA**

DO

X4

DO

|  |  |
|--|--|
|  |  |
|--|--|

---

---

---

---

---

---

---



# SRX-DO032P-EA

DO

X4

DO







DO

X5

DO



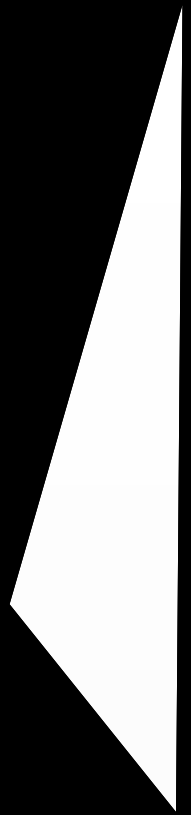



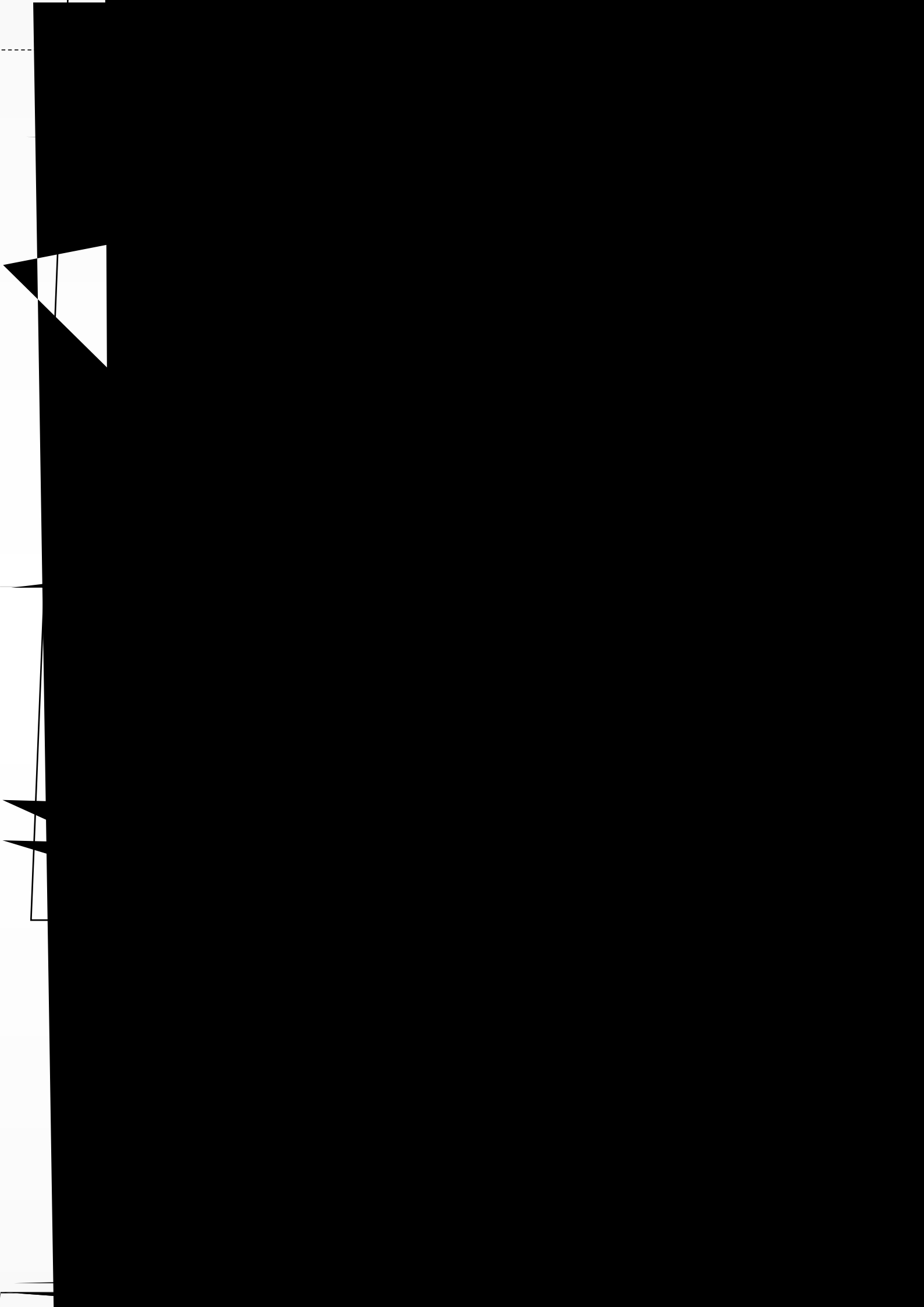

○

●

●

●

|

|

|

|

—

|



**SRX- 0604-EA**



**X4**





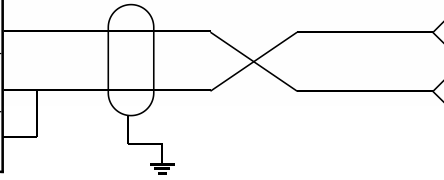
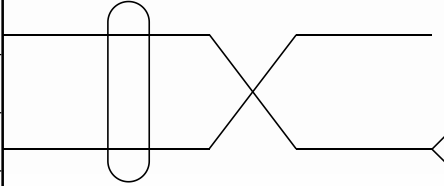

**X5**





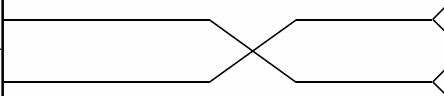
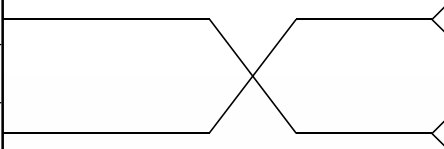

# SRX- 1200-EA

X4

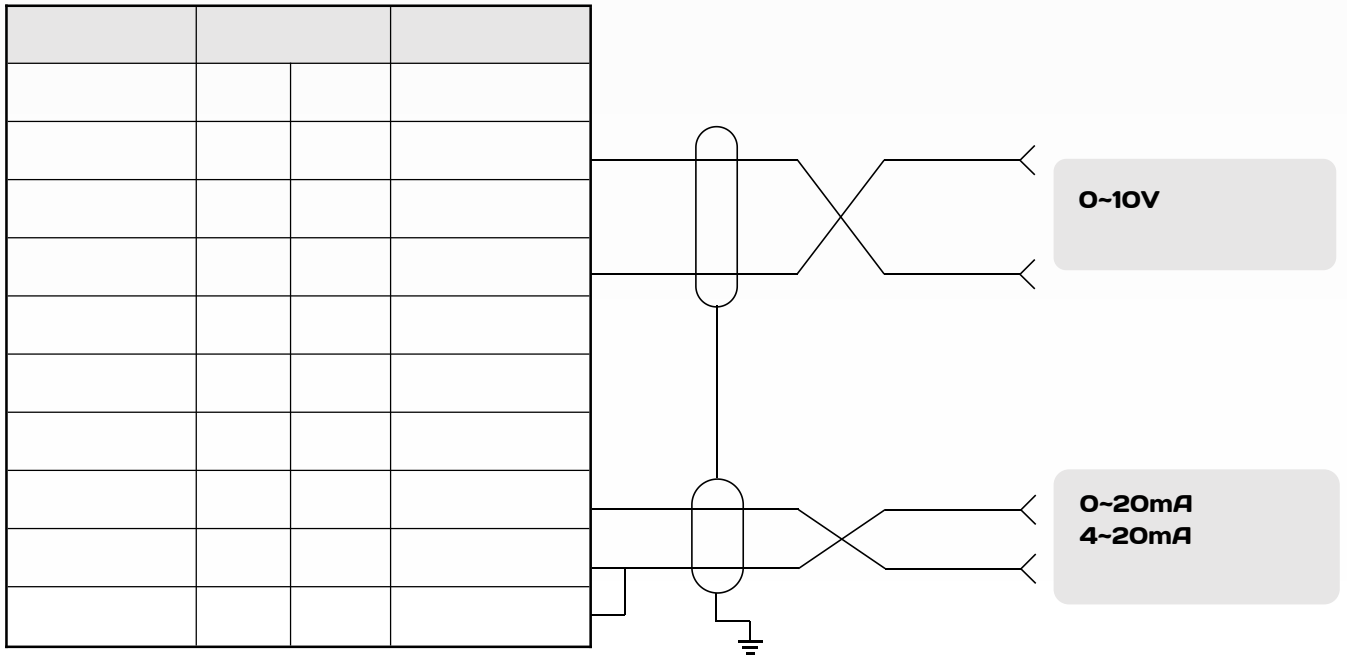

X5

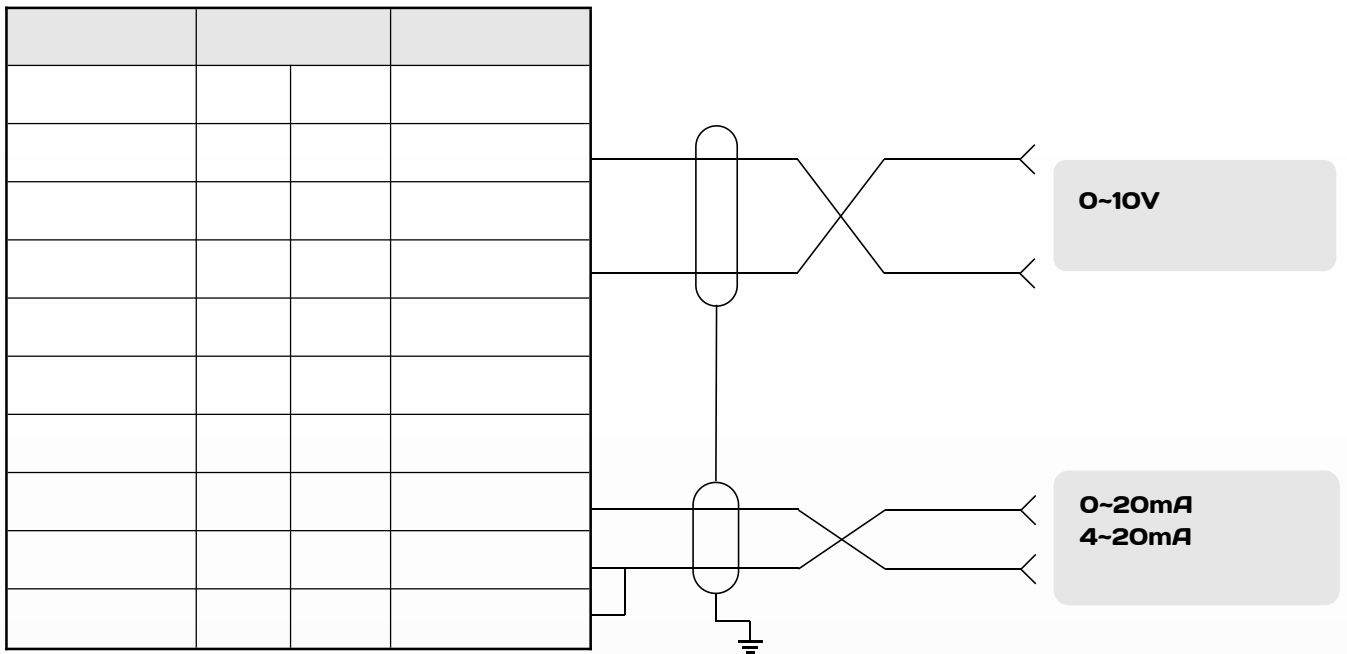

**SRX- 0008-EA**



**X4**

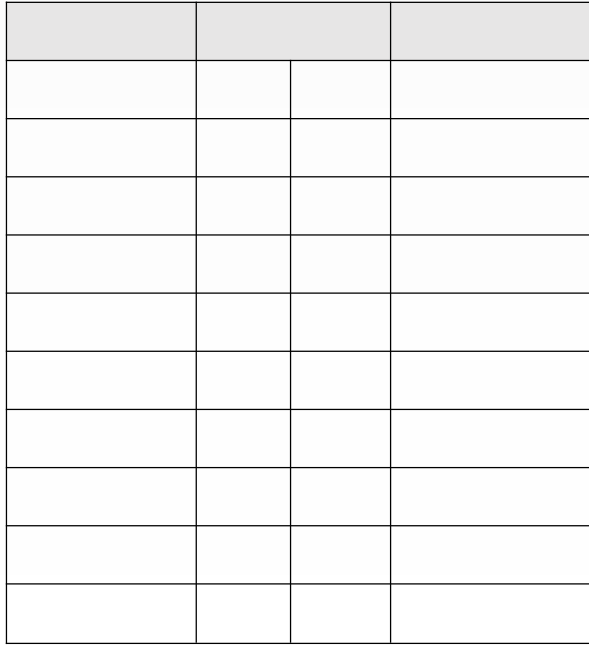

**0-20mA  
4-20mA**

**0-10V**



**X5**

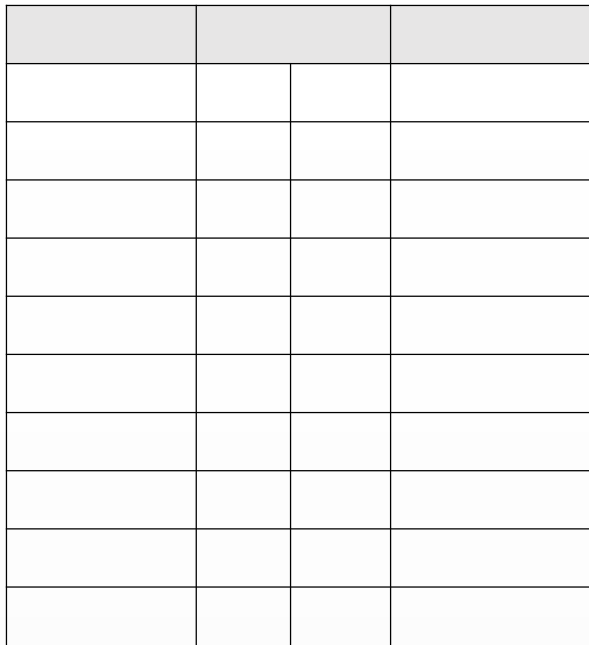

**0-20mA  
4-20mA**

**0-10V**



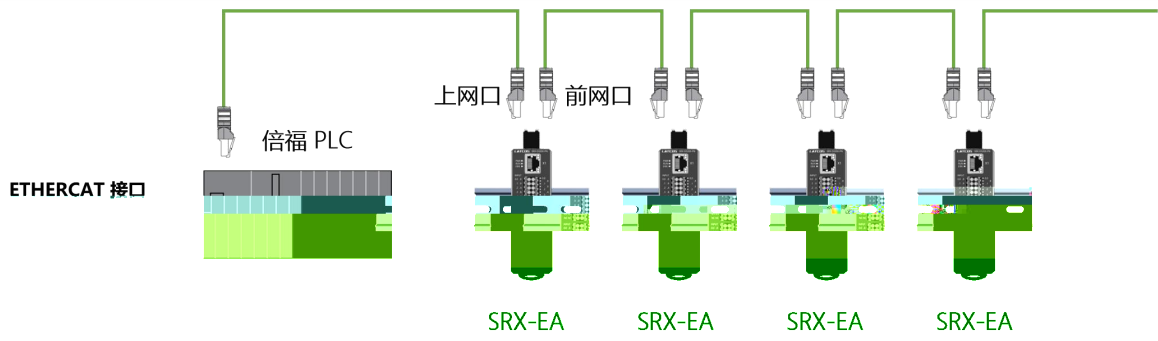





|  |  |  |  |  |  |  |  |  |
|--|--|--|--|--|--|--|--|--|
|  |  |  |  |  |  |  |  |  |
|  |  |  |  |  |  |  |  |  |
|  |  |  |  |  |  |  |  |  |
|  |  |  |  |  |  |  |  |  |
|  |  |  |  |  |  |  |  |  |
|  |  |  |  |  |  |  |  |  |

|  |  |  |  |  |  |  |  |  |
|--|--|--|--|--|--|--|--|--|
|  |  |  |  |  |  |  |  |  |
|  |  |  |  |  |  |  |  |  |
|  |  |  |  |  |  |  |  |  |
|  |  |  |  |  |  |  |  |  |

|  |  |  |  |  |  |  |  |  |
|--|--|--|--|--|--|--|--|--|
|  |  |  |  |  |  |  |  |  |
|  |  |  |  |  |  |  |  |  |
|  |  |  |  |  |  |  |  |  |
|  |  |  |  |  |  |  |  |  |
|  |  |  |  |  |  |  |  |  |
|  |  |  |  |  |  |  |  |  |
|  |  |  |  |  |  |  |  |  |



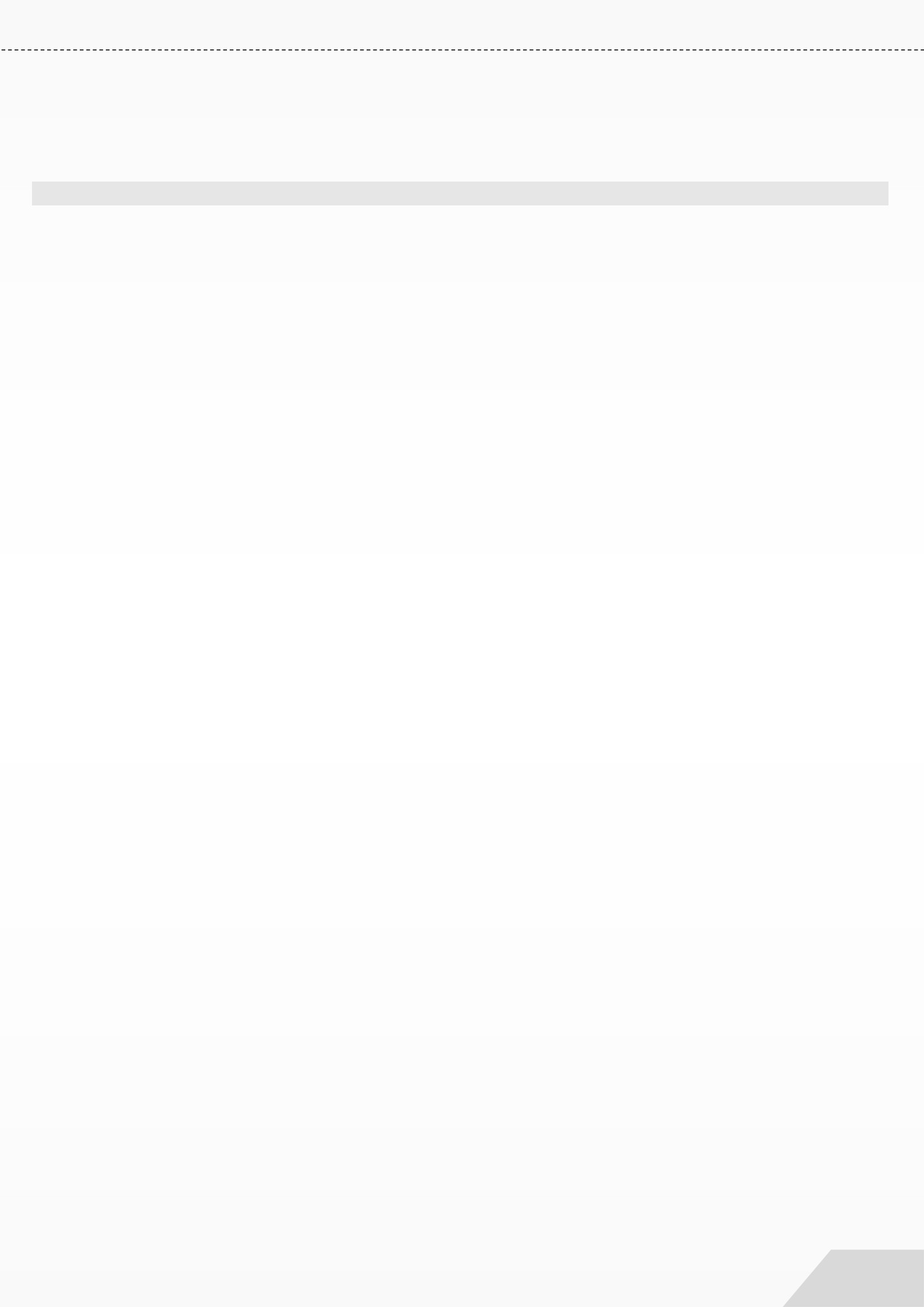

XH

FD 8 2! 5 ••%8

LD



---



---











---





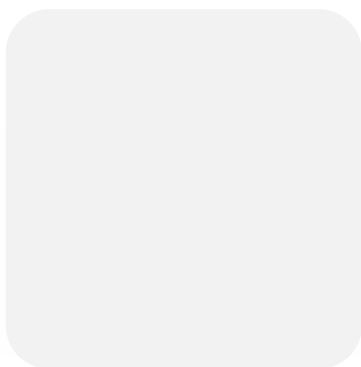

凌科自动化  
**LATOPS**

先进自动化控制及工业网络技术

